

ZeroPlay® 360 Sled Kit User Manual (DV-360ZP750B1)

For creating precision shop-built sleds and jigs.
Watch the full instructional video at: microjig.com/360sledvideo

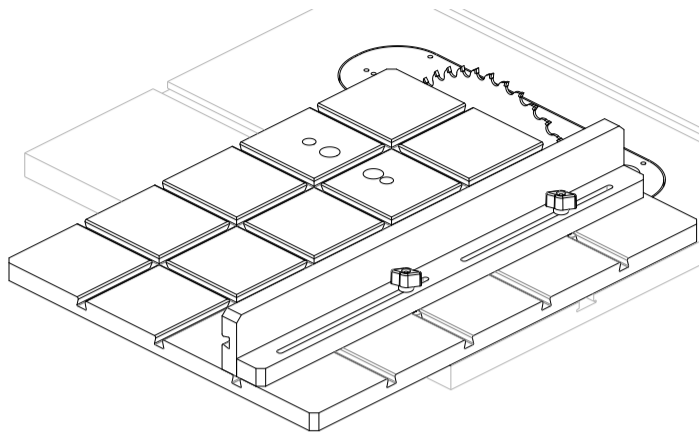

WARNING

Always wear safety glasses and hearing protection. Follow all safety precautions and use best practices. Microjig assumes no liability for any products not sold and manufactured by Microjig.

Instructions

The ZeroPlay® 360 Sled uses the MatchFit™ Dovetail Track system which allows you to position its fence at any angle while keeping the sled parallel to the blade.

The Dovetail Tracks can also be used to add custom stops and hold downs and secure parts using MatchFit™ Dovetail Clamps. This allows for safe, repeatable cuts while keeping your hands away from the blade.

Make sure that your table saw is properly tuned and maintained before using the ZeroPlay™ System. It is important that the rip fence is exactly parallel with the blade. Perform all steps as accurately as possible.

Step 1 – Create the base of the 360 Sled

- 1.1 Cut your selected piece of wood to 22" x 20" (550mm x 500mm) using a table saw as needed.
- 1.2 Cut the piece down to 16" x 20" (406mm x 500mm) in a single cut. The 6" (152mm) off-cut piece will be used for the fence in **Step 7**.

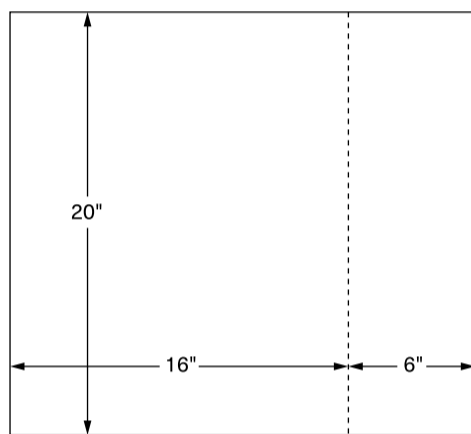

NOTE: Make sure all dimensions are accurate and corners are 90°.

Step 2 – Measure and mark Dovetail Tracks

TIP: Different saws have different miter slot locations. Laying out the ZeroPlay® mounting holes and Dovetail Track locations before drilling or cutting is recommended.

- 2.1 Set the rip fence so that it just covers the blade slot [Fig 2a].
- 2.2 Set your sled base square (90°) to the rip fence [Fig 2b].
- 2.3 Mark the center of the miter slot on the front and back edges of your sled base [Fig 2c].
- 2.4 Draw a straight line connecting these two marks [Fig 2d].
- 2.5 Measure the sled base side to side in 4" (101.6mm) increments to lay out the vertical Dovetail Tracks [Fig 2e]. Shift all track lines left or right if a track line is closer than 1-1/2" to the center line marked in the previous step. Move all lines together keeping them 4" apart.
- 2.6 Measure the sled base front to back in 4" increments to lay out the horizontal Dovetail Tracks [Fig 2f]. The ZeroPlay® mounting holes are dimensioned out to work with this spacing.

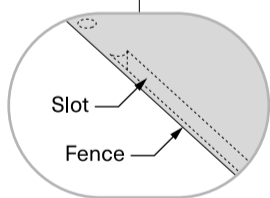
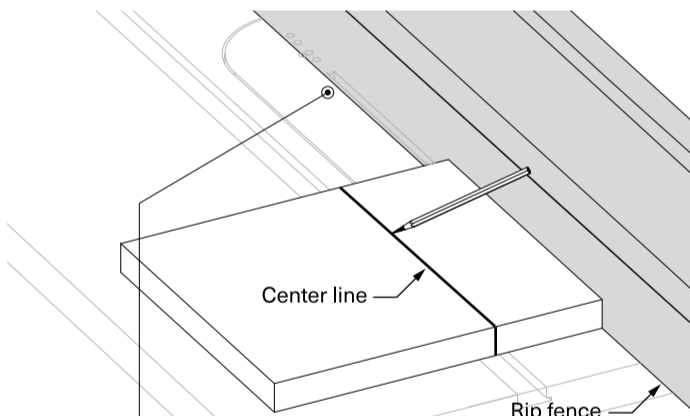

Fig 2a - Set rip fence to cover slot

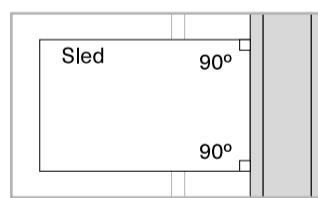

Fig 2b - Square sled 90° to rip fence

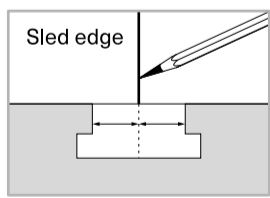

Fig 2c - Mark front & back edges

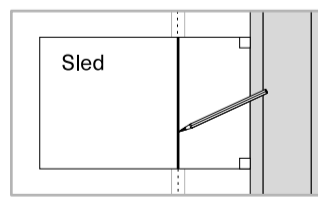

Fig 2d - Connect front & back edge marks

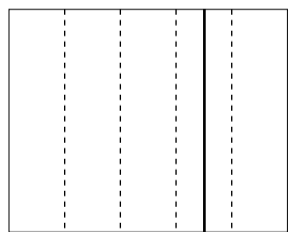

Fig 2e - Vertical Dovetail Tracks

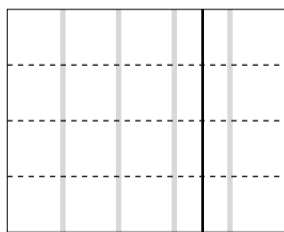

Fig 2f - Horizontal Dovetail Tracks

Step 3 – Cut relief grooves

Dovetail Tracks are 4" apart on center. All measurements are taken from the center of the bit.

- 3.1 On your router table, set a 1/4" straight bit to a cutting depth of 11/32" (9.5mm).
- 3.2 Set the router table fence to 4" and cut the four outside grooves by running each side along the fence. Rotate the workpiece 90° after each cut. (Fig 3.2)
- 3.3 After all four cuts are made, set fence to 8", and repeat previous step. Only a single cut is needed along the 20" side. (Fig. 3.3)

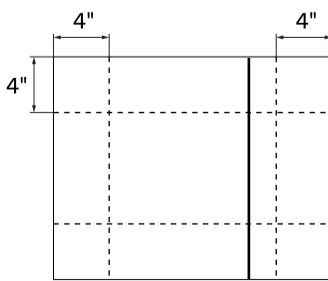

Fig 3a - Vertical Dovetail Tracks

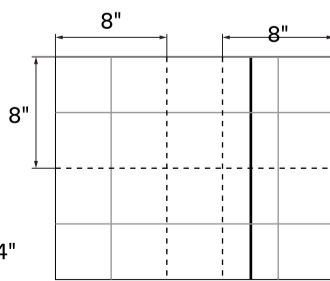

Fig 3b - Horizontal Dovetail Tracks

NOTE: An auxiliary fence is required if your router table fence can't be positioned 4" to 8" away. View plans at: microjig.com/routertablefence

Parts List

#	360 Sled Kit Parts	Qty	Part #
A	Bottom Bar (with wedges)	1	ZP750-P1
B	Top Bar (with logo)	1	ZP750-P2
C	#8-32 x 3/16" button head screw	3	ZP-H1-EH
D	3/32" hex key	1	ZP-H2-EH
E	#8-32 x 1/2" pan head screw	3	ZP-H3-EH
F	#10 flat washer	3	ZP-H4-EH
G	#8-32 x 3/4" pan head screw	3	ZP750-H19-EH
H	1.5" MatchFit™ Track Screw (#10-32)	4	DV-HL5
I	#10-32 Wing Knobs	4	GR-H52

#	Required Tools (Not included)	Qty
1	MatchFit™ OR standard 1/2" x 14° dovetail router bit	1
2	Adjustable square	1
3	3/4" forstner bit (18mm)	1
4	1/2" forstner bit (12mm)	1
5	1/4" standard drill bit (6mm)	1
6	5/16" standard drill bit (8mm)	1
7	Philips-head screwdriver	1
8	5-cent coins OR washers	2
9	3/4" thick scrap wood (18mm)	1
10	Pencil OR pen	1

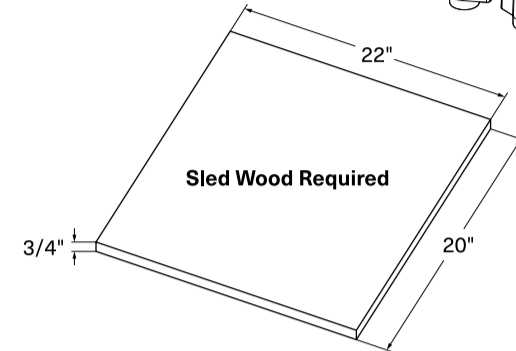
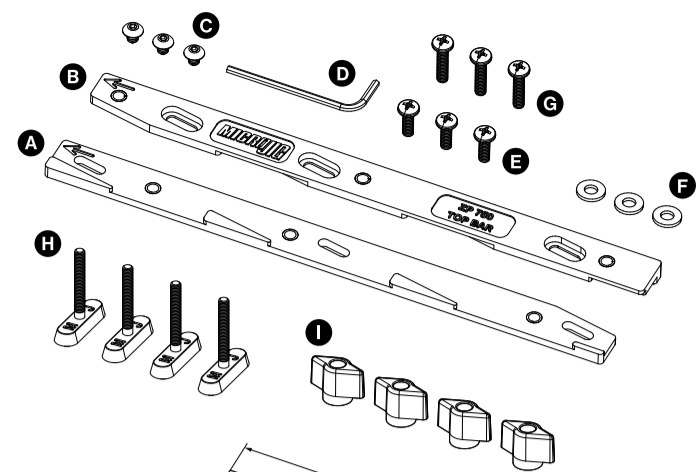

Sled wood: 22" x 20", 3/4" thick (550mm x 500mm, 18mm thick)

Wood types: void-free plywood (e.g. Baltic birch), standard MDF, or seasoned solid wood.

Compatibility

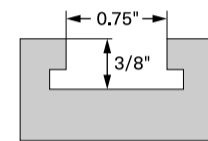

Fits most standard 3/4" miter slots on table saws, router tables, band saws, or stationary sanders. Minimum miter slot depth of 5/16" (7.94mm) required.

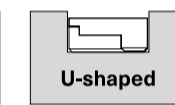
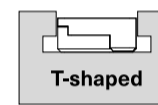

Compatible

Incompatible

Step 4 – Route Dovetail Tracks

- 4.1 Set a 1/2"-14° dovetail router bit to a cutting depth of 3/8" (9.5mm).
- 4.2 Test route a piece of scrap wood, and use the Dovetail Hardware to ensure that the dovetail bit profile and cutting depth are correct.
- 4.3 Confirm that the Dovetail Hardware remains inside the Dovetail Tracks and below the material surface when pulled up.
- 4.4 Proceed to route Dovetail Tracks in all relief grooves.

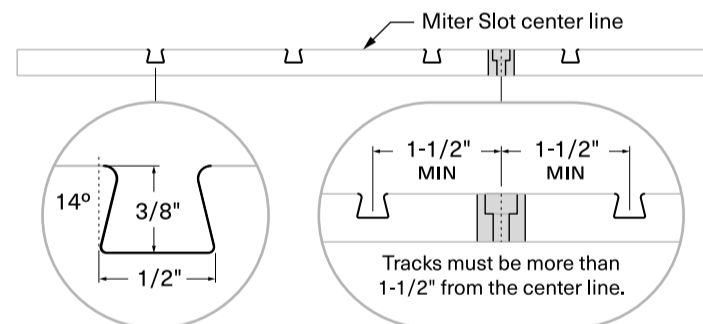

Fig 4a - Dovetail Track profile

Fig 4b - Center line spacing

Step 5 – Drill Miter Bar holes

- 5.1 Measure along the center line drawn in Step 2 and mark it at 1-3/4" (44mm) back from the front edge of the sled. Label it M1. This is the location of the first mounting hole.
- 5.2 Mark two more mounting holes at 5-3/4" (146mm) and 9-3/4" (248mm) and label them M2 and M3, respectively.
- 5.3 Mark three adjustment hole locations at 2-13/16" (71mm), 5-1/16" (129mm), and 9-1/16" (230mm). Label them as A1, A2, and A3.

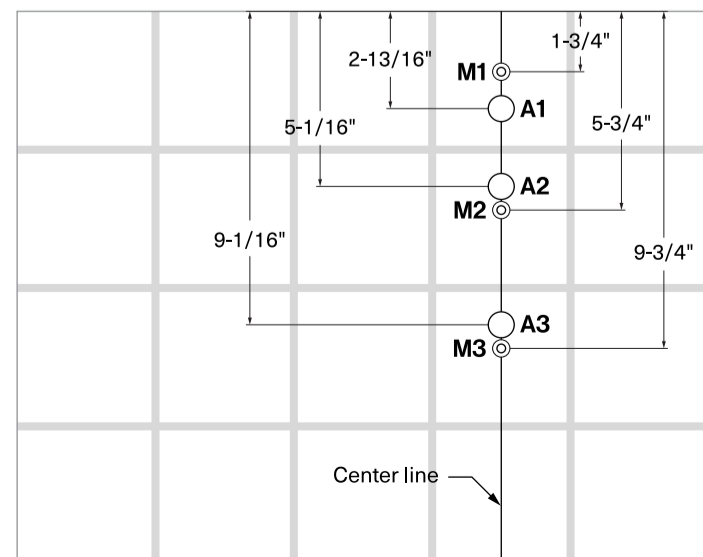

Fig 5a - Mounting and adjustment hole locations



Step 5 – Drill Miter Bar holes (Continued)

5.4 Drill 1/2" (12mm) diameter counterbores 5/16" (8mm) deep at M1, M2, and M3 using a 1/2" (12mm) forstner bit. Then drill 1/4" (6mm) thru holes at each mounting hole (M1, M2, M3) through the center of the counter bore [Fig. 2c].

5.5 Drill 3/4" (19mm) through holes at A1, A2 and A3.

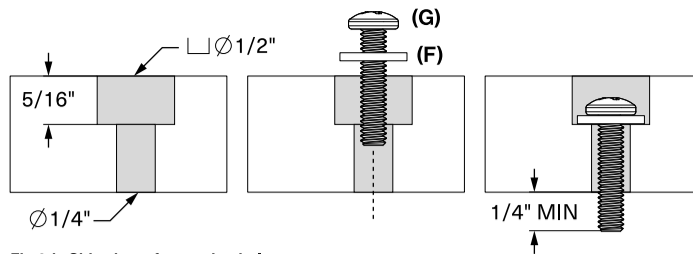

Fig 3d - Side view of mounting holes

Step 6 – Assemble and mount Miter Bar

Make sure that your table saw is properly tuned and maintained before using the ZeroPlay™ System. It is important that the rip fence is exactly parallel with the blade. Perform all steps as accurately as possible.

Miter Bar adjusts from 0.72" to 0.78" (18.3mm–19.8mm) wide. Push the bottom bar away from the top bar to decrease width [Fig 6a]. Push the bars together to widen [Fig 6b].

6.1 Adjust the bars to the narrowest setting [Fig 6a] and lightly tighten the screws.

6.2 Using a philips screwdriver, attach the Miter Bar to the bottom of the sled using (3x) 3/4" pan head screws (G) and (3x) flat washers (F). Insert the screws with washers through each mounting hole (M1, M2, M3) and tighten [Fig 6c].

6.3 Each adjustment slot should be visible through the adjustment holes (A1, A2, A3) drilled in Step 4.5.

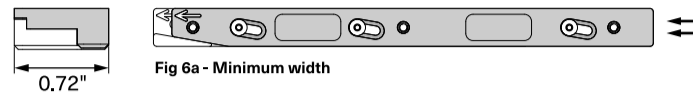

Fig 6a - Minimum width

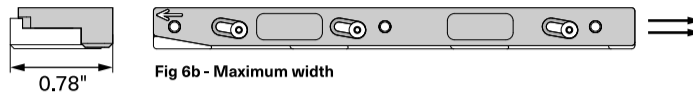

Fig 6b - Maximum width

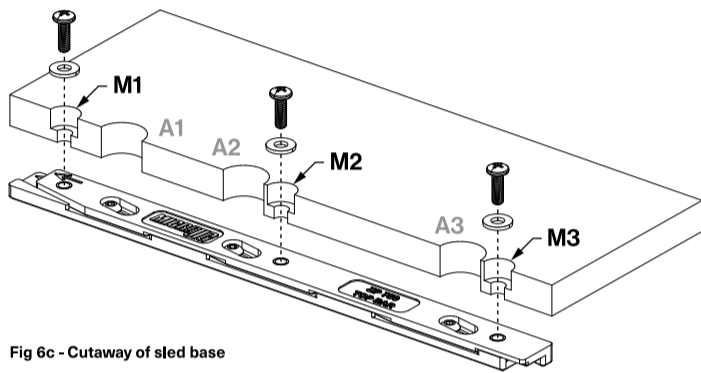
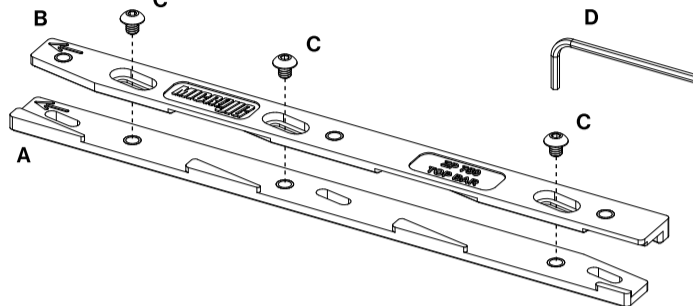

Fig 6c - Cutaway of sled base

6.4 Place the sled base on top of your table saw surface so the Miter Bar is set into one of the miter slots. Push the sled to the right so the Miter Bar is firmly against the inner wall of the miter slot [Fig 6d].

6.5 Using the hex key (D), loosen the three button head screws in the Miter Bar through the adjustment holes [Fig 6e].

6.6 Use the hex key to gently slide one of the button head screws downwards so the Miter Bar expands to completely fill the miter slot. Then, tighten each button head screw [Fig 6f].

6.7 Test the Miter Bar fit by sliding the sled along the miter slot. It should slide freely with no side-to-side play. Repeat the previous steps if the fit is too tight or too loose.

6.8 When the fit is correct, loosen the mounting screws (M) and gently slide the rip fence to the right edge of the sled base until they meet. Lock the rip fence and secure the Mounting Screws.

Your 360 Sled base is ready for the fence.

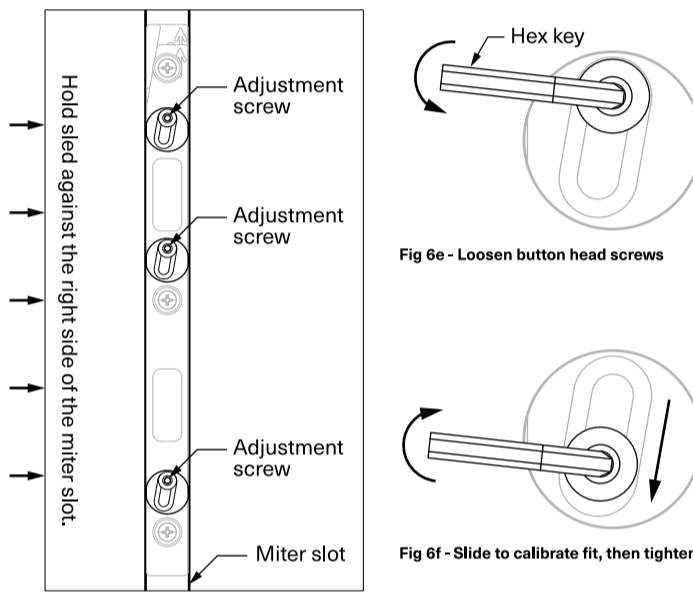

Fig 6d - Top view of assembled sled

Fig 6e - Loosen button head screws

Fig 6f - Slide to calibrate fit, then tighten

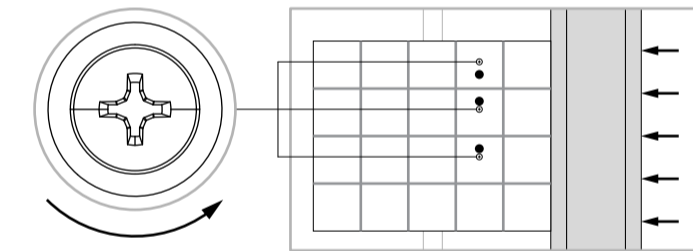
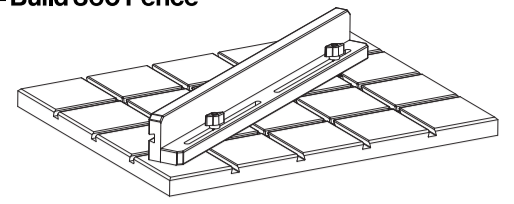

Fig 6e - Loosen mounting screws

Fig 6f - Push rip fence towards sled and tighten screws

Step 7 – Build 360 Fence



7.1 Using the off-cut piece left over from Step 1, cut a 2-1/2" (64mm) strip (Strip A), and a 1-1/4" (32mm) strip (Strip B) using your table saw [Fig 7a].

7.2 On (Strip B), mark lines at 1-1/2" (38mm) and 9" (228mm) in from each end, and a line down the length of the strip 1/2" (12mm) in from an edge. Drill 5/16" (8mm) diameter thru holes where these lines intersect. These holes will be the beginning and end points of the dovetail hardware slots [Fig 7b].

7.3 On your router table, set the 1/4" (6mm) straight bit to a cutting depth of 1/4" (6mm), and set the fence to 1/2" (12mm).

7.4 Route between the 5/16" (8mm) pre-drilled endpoints, and raise the cutting depth to 11/32" (9mm) to make a second pass.

7.5 Flip the workpiece end-over-end, and repeat until both 7.5" slots are routed all the way through (Strip B) [Fig 7c].

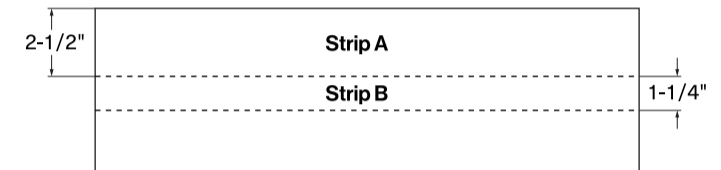

Fig 7a - Offcut wood piece for fence

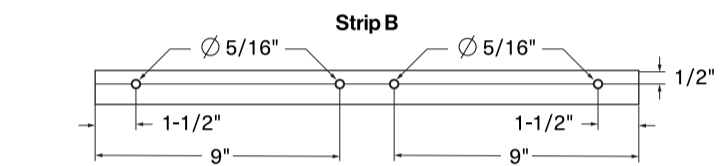

Fig 7b - Fence Strip B hole dimensions

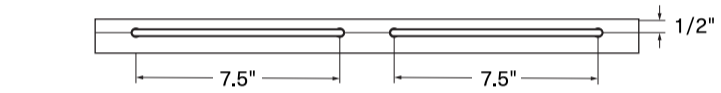

Fig 7c - Fence Strip B slot dimensions

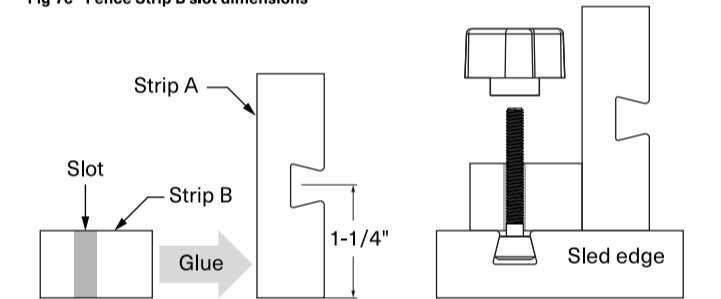

Fig 7d - 360 Fence side view

Fig 7e - Install 360 Fence on sled

7.6 Glue and clamp the edge of the (Strip B) (closest to the slots) to the top face of the (Strip A) to form a 90° L-shape [Fig 7d].

7.7 On your router table, set the fence to 1-1/4" (32mm). Route a relief groove with the 1/4" (6mm) straight bit set to a cutting depth of 11/32" (9mm).

7.8 Set the dovetail bit to a cutting depth of 3/8" (9.5mm), and route a dovetail track down the center of (Strip A) [Fig 7d].

7.9 Sand and chamfer to soften edges if desired. Attach the fence to the 360 Sled by putting the Dovetail Track Screws through the slots [Fig 7e]. Enjoy the most versatile sled in your shop!